

# elipni

1 9 5 4

## CITY

### Комплектация

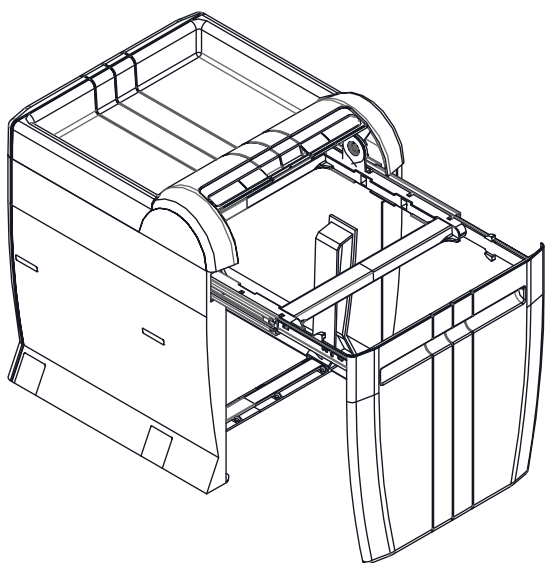

A (X1)

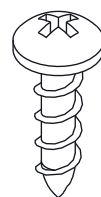

B (X8)

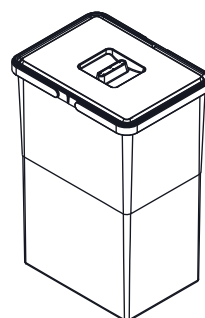

C

Количество и объем ведер различаются для разных моделей.

1

### Схемы присадочных отверстий

PTA 3040 - 3045 : S1 = 170 mm , S2 = 260 mm

PTA 4040 - 4045 : S1 = 245 mm , S2 = 260 mm

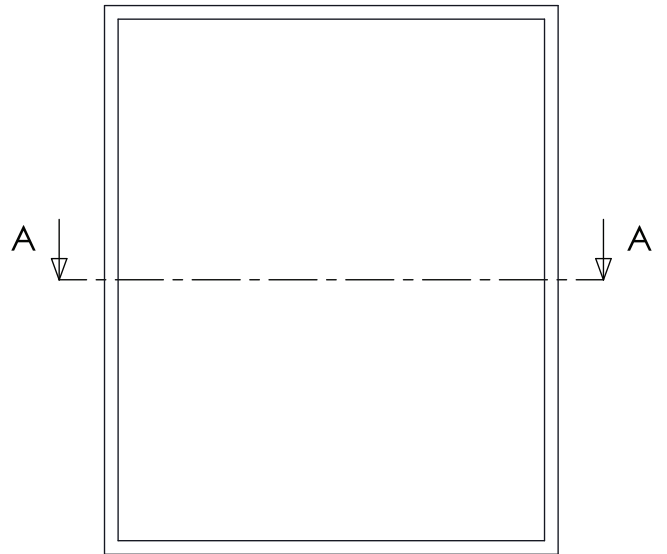
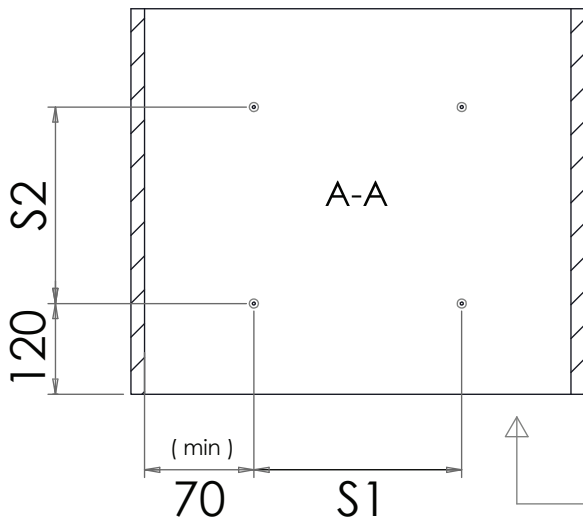

Фронтальная плоскость корпуса

2

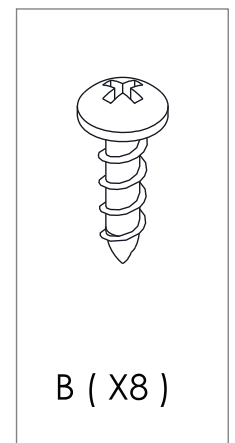
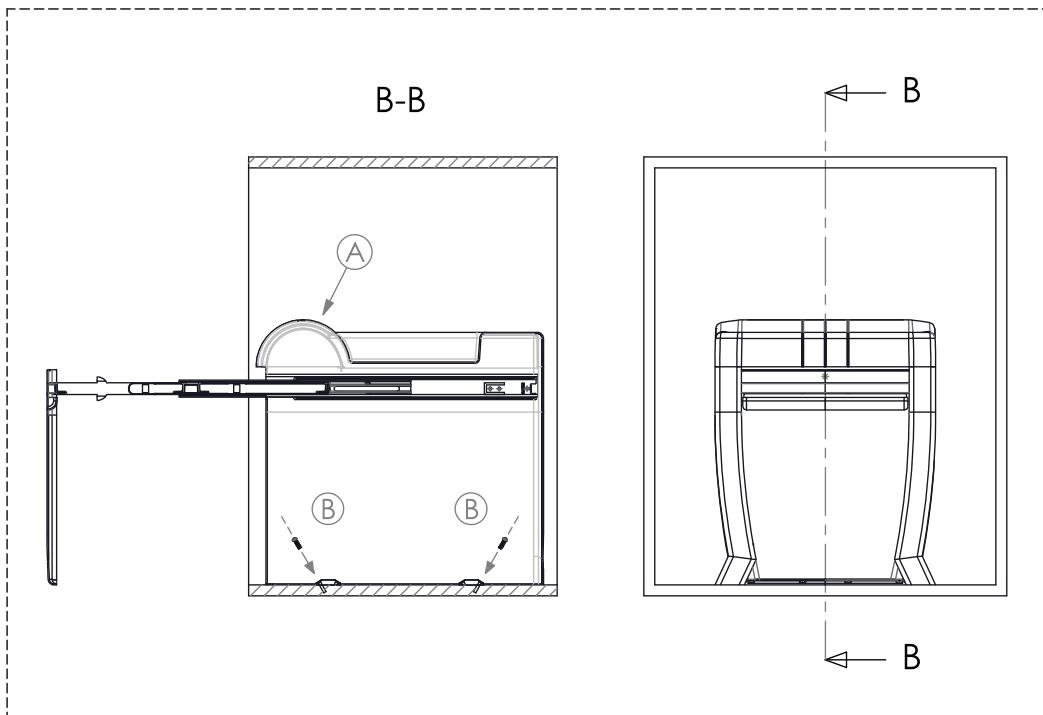

B ( X8 )

A ( X1 )

PTA 3040B ( 18 λ )

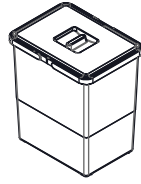

PTA 4045B ( 18 λ + 18 λ )

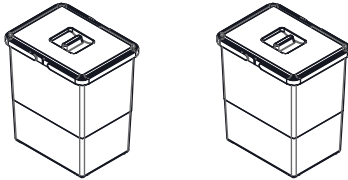

PTA 3045B ( 12 λ + 12 λ )

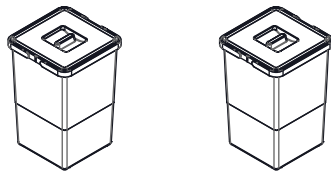

PTA 3040

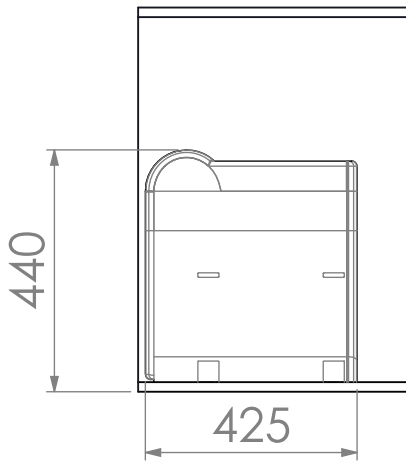

PTA 3045

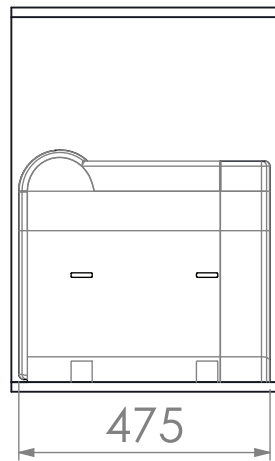

PTA 3040 - 3045

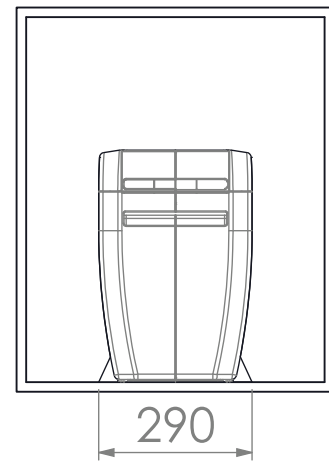

PTA 4045

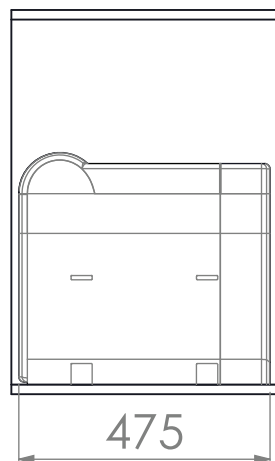

PTA 4040 - 4045

